



GASKET REFERENCE GUIDE

Quick Gasket Reference	1
Spiral Wound Gasket Identification	
Ring Color Coding	7
Non-metallic Filler Materials	9
Metallic Winding Materials	9
Flange Face Designs	11
Gasket Assembly, Bolting and Compression	
Gasket Installation and Surface Finish Recommendations	13
Bolting Recommendations	17
Gasket Installation, Torque Sequence	19
Torque Data	
Required Gasket Compression for Spiral Wound Gaskets	27
Torque Data Technical Notes	29
Torque Data: Spiral Wound CG	31
Torque Data: Spiral Wound CGI	37
Torque Data: Thermiculite 715	43
Torque Data: Thermiculite 815	45
Torque Data: Flexpro	47
Bolting Data	
ASME B16.5 & BS1560 Flanges	53
Legal Disclaimer	67



Thermiculite®

innovative. versatile. complete.

- » High Temperature
up to 1800° F (982°C)
- » Replaces Flexible Graphite
- » Fire Safe
- » 150# - 2500# class flanges



CG Spiral Wound

CGI Spiral Wound

**845 Flexpro™
(Kammprofile)**

Flexitallic can make any shape or size you require.
Call 281.604.2400 for immediate assistance.



- » Aggressive Chemicals
- » pH 0-14
- » Max Temp: 500° F (260°C)
- » 150# - 300# class flanges

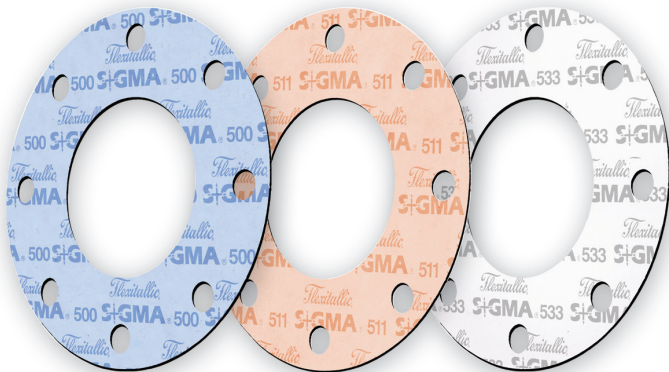

Sigma 500

Moderate Acids & Caustics,
Chlorine, Hydrogen Peroxide,
Sulfuric Acid

Sigma 511

Strong Acids

Sigma 533

Strong Caustics

Flexitallic can make any shape or size you require.

Call **281.604.2400** for immediate assistance.



Flexitallic can make any shape or size you require. Call **281.604.2400** for immediate assistance.



SF2401

General Service
up to 662° F (350°C)



Sigma 600

Aggressive Chemicals
Non-metallic flanges
Max Temp: 500°F (260°C)
pH 0-14



Thermiculite 715

Replaces All Fiber and
Graphite Gaskets up to
850°F (454°C)



Thermiculite 815

Replaces All Fiber and
Graphite Gaskets up to
1800°F (982°C)

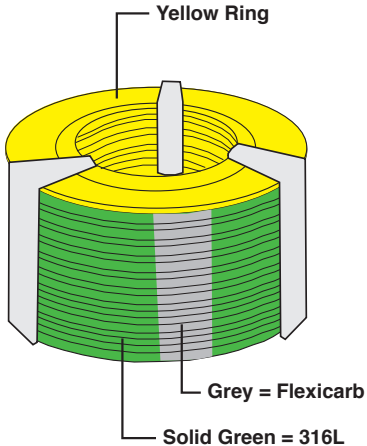

Ring Color Coding

Gaskets are color coded to help expedite the selection and identification of the gaskets you need.

The color of the outside edge of the centering ring identifies both the winding and filler materials.





















The metallic winding filler materials are designated by color stripes at equal intervals on the outside edge of the centering ring.

The Flexitallic color code meets the industry standard for metal and filler materials which has been adopted by ASME B16.20 and the Metallic Gasket division of the Fluid Sealing Association.

Non-metallic Filler Materials

	PTFE		Ceramic
	Flexicarb		Thermiculite 735
	Flexite Super		Thermiculite 835

Metallic Winding Materials

	304SS		Titanium
	316L SS		Inconel 600/625
	317L		Incoloy 800/825
	321SS		Inconel X750
	347SS		Hastelloy C276
	310SS		Hastelloy B2
	304LSS		Nickel 200
	309SS		Zirconium
	430SS		Carbon Steel
	Alloy 20		Monel

Flange Face Designs

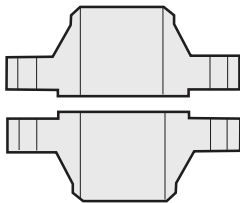

Raised Face

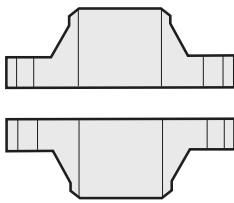

Flat Face

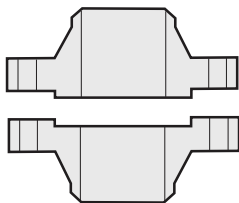

Male and Female

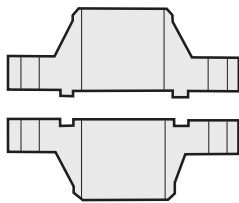

Tongue and Groove

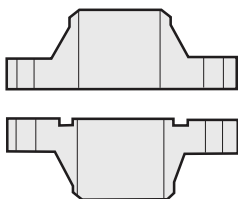





Flat Face to Recess

Flange Inspection

1. Ensure flange faces are clean and free from imperfections. These could be detrimental to the sealing performance.
2. Carefully remove any solid residue from the flanges, using scrapers, wire brush or cloth.

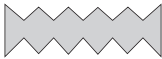
Gasket Installation, Surface Finish Recommendations

Gasket Description	Gasket Cross Section	Flange Surface Finish Microinch Ra	Flange Surface Finish Micrometer Ra
Spiral Wound Gaskets		125 - 250	3.2 - 6.3
Flexpro Gaskets		125 - 250	3.2 - 6.3
Metallic Serrated Gaskets		63 MAX	1.6 MAX
MRG		125 - 250	3.2 - 6.3

Gasket Installation, Surface Finish Recommendations Continued

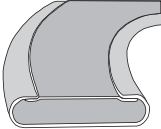
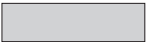
Gasket Description	Gasket Cross Section	Flange Surface Finish Microinch Ra	Flange Surface Finish Micrometer Ra
Solid Metal Gaskets		63 MAX	1.6 MAX
Metal Jacketed Gaskets		100 - 125	2.5 MAX
Soft Cut Sheet Gaskets		Mat'l < 1.5mm Thick 125 - 250	Mat'l < 1.5mm Thick 3.2 - 6.3
		Mat'l > 1.5mm Thick 125 - 500	Mat'l > 1.5mm Thick 3.2 - 12.5

Important: Under no circumstances should flange sealing surfaces be machined in a manner that tool marks would extend radially across the sealing surface. Such tool marks are practically impossible to seal regardless of the type of gasket used.

Bolting Recommendations

When utilizing Torque wrenches the use of suitable lubricants on the stud threads and nut bearing faces is recommended, e.g. Molybdenum di-sulphide or Nickel powder anti-seize compounds.

We recommend a four stage tightening method as follows:

1. Torque the bolts at 30% of the final loading using the appropriate bolt pattern.
2. 60% of final load.
3. 100% of final load.
4. 100% of final torque using a clockwise pattern.

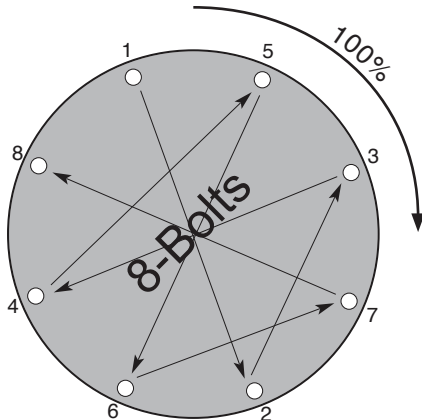

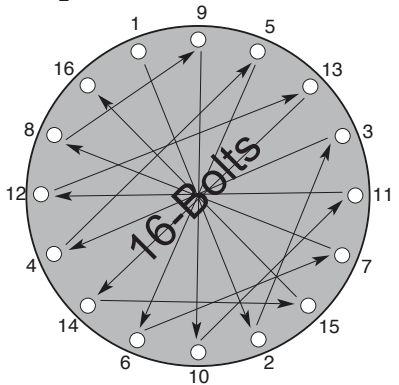
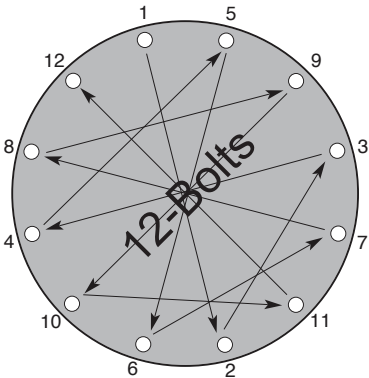
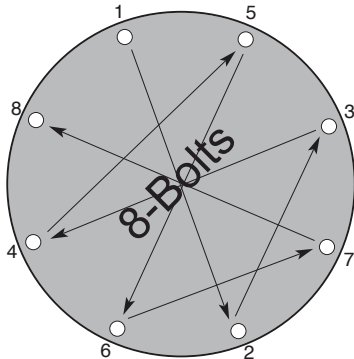

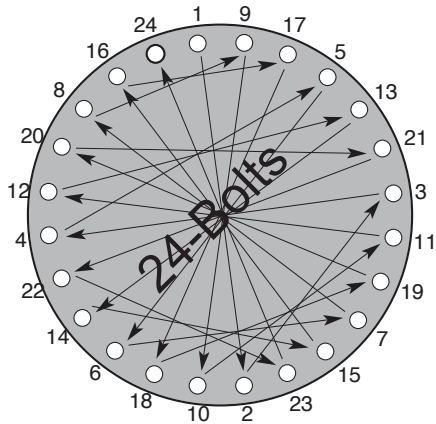
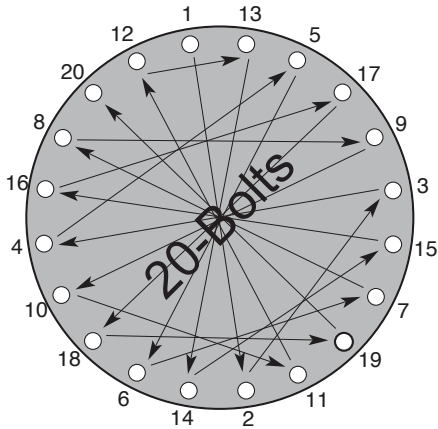

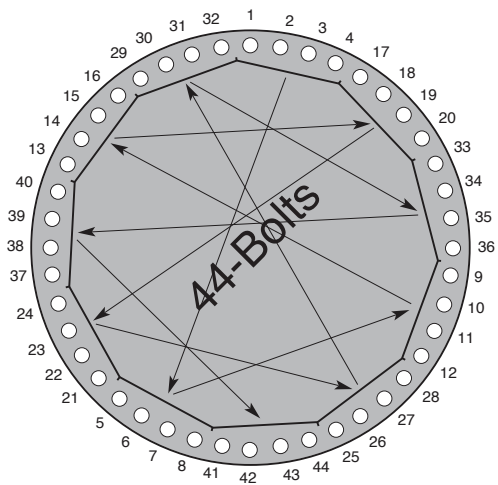
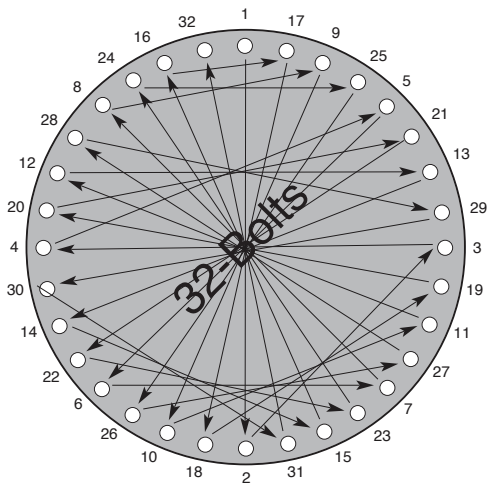

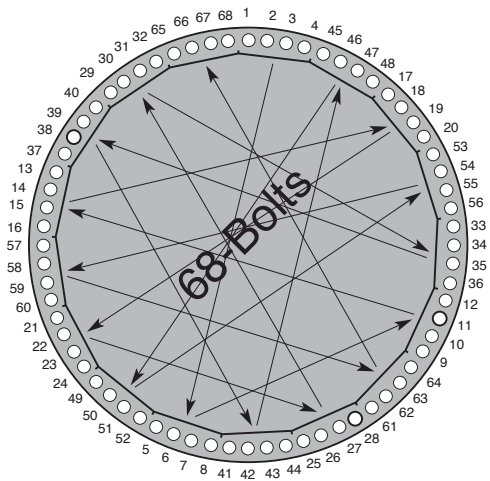
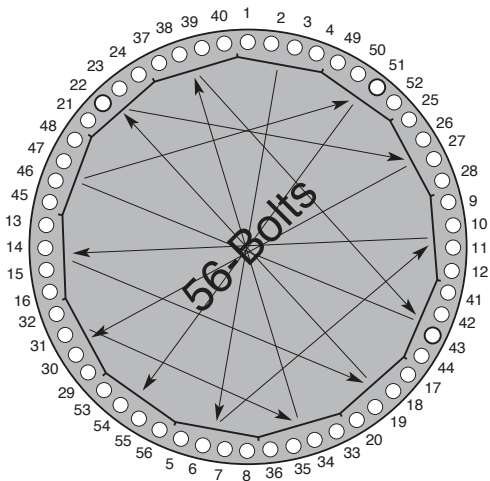

Required Gasket Compression for Spiral Wound Gaskets

Spiral Wound Gaskets with internal or external rings, i.e. Styles 'CG' and 'CGI' can be compressed to the ring thickness, if necessary. This will not damage the gasket or affect the sealing performance and the ring is provided as a compression limiting stop.

For optimum performance Flexitallic Spiral Wound Gaskets should be compressed to these thicknesses.

INITIAL GASKET THICKNESS	RECOMMENDED COMPRESSED THICKNESS
1.6 mm (0.0625 in)	1.3/1.4 mm (0.050/0.055 in)
2.5 mm (0.100 in)	1.9/2.0 mm (0.075/0.080 in)
3.2 mm (0.125 in)	2.3/2.5 mm (0.090/0.100 in)
4.4 mm (0.175 in)	3.2/3.4 mm (0.125/0.135 in)
6.4 mm (0.250 in)	4.6/5.1 mm (0.180/0.200 in)
7.2 mm (0.285 in)	5.1/5.6 mm (0.200/0.220 in)

Torque Data Technical Notes

Torque Values are in ft.-lbs., and assume Alloy Steel Bolts (A193 B7 w/ 2H Nuts) with oil/graphite lubrication.

(Nut factors used on these charts are within .15 to .19)

Flexitallic does not generally recommend a bolt stress above 60,000 PSI

Torque values limit minimum and maximum gasket seating stresses based upon pressure class and certain operating conditions.(i.e: maximum pressure ratings for given pressure class,not hydrotest pressure). Extreme operating conditions such as high temperature may reduce bolt yield strength. Caution should be used in these applications. The following torque values are for general use only. For critical or extreme applications (high temperature/pressure) consult with Flexitallic engineering.

Flexitallic does not accept responsibility for the misuse of this information.

Torque Data: Spiral Wound CG

NPS (in.)	Class 150		Class 300	
	Min Torque	Max Torque	Min Torque	Max Torque
0.5	30	40	30	40
0.75	30	40	60	70
1	30	40	60	70
1.25	30	40	60	70
1.5	30	60	100	120
2	60	90	60	70
2.5	60	110	100	120
3	90	120	100	120
3.5	60	90	100	120
4	70	120	100	140
5	100	160	110	160
6	130	200	110	160
8	180	200	180	260
10	170	320	250	290
12	240	320	360	420
14	300	490	360	420
16	310	490	500	590
18	500	710	500	680
20	430	710	500	740
24	620	1000	800	1030

Torque Data: Spiral Wound CG

NPS (in.)	Class 400		Class 600	
	Min Torque	Max Torque	Min Torque	Max Torque
0.5	30	40	30	40
0.75	60	70	60	70
1	60	70	60	70
1.25	60	70	60	70
1.5	100	120	100	120
2	60	70	60	70
2.5	100	120	100	120
3	100	120	100	120
3.5	160	190	170	210
4	160	200	190	240
5	210	260	280	360
6	190	240	260	330
8	310	400	400	510
10	340	440	500	590
12	510	640	500	610
14	500	890	680	800
16	680	800	800	940
18	680	810	1100	1290
20	800	940	1100	1290
24	1500	1750	2000	2340

Torque Data: Spiral Wound CG

NPS (in.)	Class 900		Class 1500		Class 2500	
	Min Torque	Max Torque	Min Torque	Max Torque	Min Torque	Max Torque
0.5	70	120	70	120	50	100
0.75	70	120	70	120	70	100
1	110	190	110	190	110	160
1.25	110	190	135	190	210	250
1.5	170	290	200	290	310	360
2	110	190	130	190	220	250
2.5	170	290	190	290	300	360
3	140	230	265	360	460	500
4	255	420	415	520	Not Applicable Use CGI	
5	360	600	585	800		
6	300	500	530	680		
8	485	800	845	1100		
10	505	800	1565	2000		
12	570	850	Not Applicable Use CGI			
14	630	940				
16	910	1290				
18	1570	2340				
20	1745	2570				
24	Not Applicable Use CGI					

Torque Data: Spiral Wound CGI

NPS (in.)	Class 150		Class 300	
	Min Torque	Max Torque	Min Torque	Max Torque
0.5	30	50	30	40
0.75	30	50	60	80
1	30	60	60	80
1.25	30	60	60	80
1.5	30	60	100	140
2	60	120	60	80
2.5	60	120	100	140
3	90	120	100	150
3.5	60	120	100	170
4	70	120	100	200
5	100	200	110	200
6	130	200	110	200
8	180	200	180	320
10	170	320	250	460
12	240	320	360	700
14	300	490	360	610
16	310	490	500	920
18	490	710	500	1000
20	430	710	500	1000
24	620	1000	800	1600

Torque Data: Spiral Wound CGI

NPS (in.)	Class 400		Class 600	
	Min Torque	Max Torque	Min Torque	Max Torque
0.5	30	40	30	40
0.75	60	80	60	80
1	60	80	60	80
1.25	60	80	60	80
1.5	100	140	100	140
2	60	80	60	80
2.5	100	140	100	140
3	100	150	100	150
3.5	160	290	170	290
4	160	320	190	320
5	210	320	280	490
6	190	320	260	460
8	310	490	400	700
10	360	710	500	800
12	510	1000	500	850
14	500	870	680	950
16	680	1250	800	1210
18	680	1340	1100	1790
20	800	1430	1100	1640
24	1500	2270	2000	2670

Torque Data: Spiral Wound CGI

NPS (in.)	Class 900		Class 1500		Class 2500	
	Min Torque	Max Torque	Min Torque	Max Torque	Min Torque	Max Torque
0.5	70	120	70	120	50	100
0.75	70	120	70	120	63	100
1	110	190	110	190	110	160
1.25	110	190	140	190	210	250
1.5	170	290	200	290	310	360
2	110	190	130	190	220	250
2.5	170	290	190	290	300	360
3	140	230	270	360	460	500
4	260	420	420	520	710	800
5	360	600	590	800	1280	1500
6	300	500	530	680	1870	2200
8	485	800	850	1100	1780	2200
10	505	800	1570	2000	3040	4400
12	560	850	1500	2200	4610	5920
14	630	940	2120	3180		
16	910	1290	2940	4400		
18	1570	2340	3950	5920		
20	1745	2570	5150	7720		
24	2945	5140	8340	12500		

Torque Data: Thermiculite 715 (1/16" thickness)*

NPS (in.)	Class 150		Class 300	
	Min Torque	Max Torque	Min Torque	Max Torque
0.5	15	40	15	40
0.75	15	55	30	70
1	15	60	30	90
1.25	25	60	30	120
1.5	30	60	50	200
2	65	120	35	120
2.5	75	120	50	190
3	105	120	60	200
3.5	60	120	65	200
4	75	120	85	200
5	105	200	105	200
6	130	200	90	200
8	175	200	135	320
10	170	320	145	500
12	220	320	210	710
14	280	490	185	710
16	270	490	255	1000
18	400	710	290	1000
20	350	710	320	1000
24	500	1000	460	1600

*For thicknesses other than 1/16" consult Flexitallic Engineering.

Torque Data: Thermiculite 815 (1/16" thickness)*

NPS (in.)	Class 150		Class 300	
	Min Torque	Max Torque	Min Torque	Max Torque
0.5	15	35	15	35
0.75	15	50	30	70
1	15	60	30	80
1.25	20	60	30	120
1.5	25	60	50	185
2	50	120	30	120
2.5	60	120	50	175
3	90	120	50	200
3.5	50	120	55	200
4	60	120	70	200
5	85	200	85	200
6	110	200	75	200
8	150	200	115	320
10	140	320	135	500
12	185	320	200	710
14	235	500	185	710
16	220	500	255	1000
18	330	710	270	1000
20	290	710	320	1000
24	415	1000	460	1600

*For thicknesses other than 1/16" consult Flexitallic Engineering.

Torque Data: Flexpro

NPS (in.)	Class 150		Class 300	
	Min Torque	Max Torque	Min Torque	Max Torque
0.5	15	50	30	45
0.75	15	50	30	80
1	15	60	30	90
1.25	30	60	50	120
1.5	30	60	65	200
2	60	120	45	120
2.5	60	120	65	200
3	90	120	90	200
3.5	60	120	100	200
4	75	120	100	200
5	100	200	100	200
6	120	200	100	200
8	160	200	160	300
10	160	320	240	490
12	160	320	300	710
14	280	490	300	710
16	245	490	420	1000
18	360	710	420	1000
20	360	710	500	1000
24	500	1000	650	1600

Torque Data: Flexpro

NPS (in.)	Class 400		Class 600	
	Min Torque	Max Torque	Min Torque	Max Torque
0.5	30	40	30	45
0.75	60	80	60	80
1	60	80	60	85
1.25	60	100	60	120
1.5	100	135	100	200
2	60	80	60	120
2.5	100	135	100	180
3	100	175	100	200
3.5	160	225	160	320
4	160	290	160	320
5	160	320	245	490
6	160	320	245	490
8	245	490	355	710
10	355	586	500	940
12	500	770	500	900
14	500	670	680	1070
16	680	1005	800	1370
18	680	1110	1100	2050
20	800	1185	1100	1880
24	1500	2140	2000	2940

Torque Data: Flexpro

NPS (in.)	Class 900		Class 1500		Class 2500	
	Min Torque	Max Torque	Min Torque	Max Torque	Min Torque	Max Torque
0.5	70	120	70	120	50	100
0.75	70	120	70	120	70	100
1	110	190	110	190	105	160
1.25	110	190	110	190	210	245
1.5	165	290	170	290	290	355
2	110	190	110	190	185	245
2.5	165	290	170	290	255	355
3	125	200	245	355	445	500
4	240	415	400	500	700	800
5	350	585	560	800	1240	1500
6	285	455	520	680	1835	2200
8	480	795	805	1100	1700	2200
10	500	795	1480	2000	2915	4400
12	535	795	1470	2200	4295	5920
14	600	935	2120	3180		
16	895	1285	2935	4400		
18	1520	2335	3950	5920		
20	1720	2570	5150	7720		
24	2950	5135	8335	12500		

Bolting Data for ASME B16.5 & BS 1560 Flanges

Nominal Pipe Size	Class 150			
	Flange Dia.	No. of Bolts	Bolt Diameter	B.C. Diameter
1/4	3-3/8	4	1/2	2-1/4
1/2	3-1/2	4	1/2	2-3/8
3/4	3-7/8	4	1/2	2-3/4
1	4-1/4	4	1/2	3-1/8
1-1/4	4-5/8	4	1/2	3-1/2
1-1/2	5	4	1/2	3-7/8
2	6	4	5/8	4-3/4
2-1/2	7	4	5/8	5-1/2
3	7-1/2	4	5/8	6
3-1/2	8-1/2	8	5/8	7
4	9	8	5/8	7-1/2
5	10	8	3/4	8-1/2
6	11	8	3/4	9-1/2
8	13-1/2	8	3/4	11-3/4
10	16	12	7/8	14-1/4
12	19	12	7/8	17
14	21	12	1	18-3/4
16	23-1/2	16	1	21-1/4
18	25	16	1-1/8	22-3/4
20	27-1/2	20	1-1/8	25
24	32	20	1-1/4	29-1/2

Bolting Data for ASME B16.5 & BS 1560 Flanges

Nominal Pipe Size	Class 300			
	Flange Dia.	No. of Bolts	Bolt Diameter	B.C. Diameter
1/4	3-3/8	4	1/2	2-1/4
1/2	3-3/4	4	1/2	2-5/8
3/4	4-5/8	4	5/8	3-1/4
1	4-7/8	4	5/8	3-1/2
1-1/4	5-1/4	4	5/8	3-7/8
1-1/2	6-1/8	4	3/4	4-1/2
2	6-1/2	8	5/8	5
2-1/2	7-1/2	8	3/4	5-7/8
3	8-1/4	8	3/4	6-5/8
3-1/2	9	8	3/4	7-1/4
4	10	8	3/4	7-7/8
5	11	8	3/4	9-1/4
6	12-1/2	12	3/4	10-5/8
8	15	12	7/8	13
10	17-1/2	16	1	15-1/4
12	20-1/2	16	1-1/8	17-3/4
14	23	20	1-1/8	20-1/4
16	25-1/2	20	1-1/4	22-1/2
18	28	24	1-1/4	24-3/4
20	30-1/2	24	1-1/4	27
24	36	24	1-1/2	32

Bolting Data for ASME B16.5 & BS 1560 Flanges

Nominal Pipe Size	Class 400			
	Flange Dia.	No. of Bolts	Bolt Diameter	B.C. Diameter
1/4	3-3/8	4	1/2	2-1/4
1/2	3-3/4	4	1/2	2-5/8
3/4	4-5/8	4	5/8	3-1/4
1	4-7/8	4	5/8	3-1/2
1-1/4	5-1/4	4	5/8	3-7/8
1-1/2	6-1/8	4	3/4	4-1/2
2	6-1/2	8	5/8	5
2-1/2	7-1/2	8	3/4	5-7/8
3	8-1/4	8	3/4	6-5/8
3-1/2	9	8	7/8	7-1/4
4	10	8	7/8	7-7/8
5	11	8	7/8	9-1/4
6	12-1/2	12	7/8	10-5/8
8	15	12	1	13
10	17-1/2	16	1-1/8	15-1/4
12	20-1/2	16	1-1/4	17-3/4
14	23	20	1-1/4	20-1/4
16	25-1/2	20	1-3/8	22-1/2
18	28	24	1-3/8	24-3/4
20	30-1/2	24	1-1/2	27
24	36	24	1-3/4	32

Bolting Data for ASME B16.5 & BS 1560 Flanges

Nominal Pipe Size	Class 600			
	Flange Dia.	No. of Bolts	Bolt Diameter	B.C. Diameter
1/4	3-3/8	4	1/2	2-1/4
1/2	3-3/4	4	1/2	2-5/8
3/4	4-5/8	4	5/8	3-1/4
1	4-7/8	4	5/8	3-1/2
1-1/4	5-1/4	4	5/8	3-7/8
1-1/2	6-1/8	4	3/4	4-1/2
2	6-1/2	8	5/8	5
2-1/2	7-1/2	8	3/4	5-7/8
3	8-1/4	8	3/4	6-5/8
3-1/2	9	8	7/8	7-1/4
4	10-3/4	8	7/8	8-1/2
5	13	8	1	10-1/2
6	14	12	1	11-1/2
8	16-1/2	12	1-1/8	13-3/4
10	20	16	1-1/4	17
12	22	20	1-1/4	19-1/4
14	23-3/4	20	1-3/8	20-3/4
16	27	20	1-1/2	23-3/4
18	29-1/4	20	1-5/8	25-3/4
20	32	24	1-5/8	28-1/2
24	37	24	1-7/8	33

Bolting Data for ASME B16.5 & BS 1560 Flanges

Nominal Pipe Size	Class 900			
	Flange Dia.	No. of Bolts	Bolt Diameter	B.C. Daimeter
1/2	4-3/4	4	3/4	3-1/4
3/4	5-1/8	4	3/4	3-1/2
1	5-7/8	4	7/8	4
1-1/4	6-1/4	4	7/8	4-3/8
1-1/2	7	4	1	4-7/8
2	8-1/2	8	7/8	6-1/2
2-1/2	9-5/8	8	1	7-1/2
3	9-1/2	8	7/8	7-1/2
4	11-1/2	8	1-1/8	9-1/4
5	13-3/4	8	1-1/4	11
6	15	12	1-1/8	12-1/2
8	18-1/2	12	1-3/8	15-1/2
10	21-1/2	16	1-3/8	18-1/2
12	24	20	1-3/8	21
14	25-1/4	20	1-1/2	22
16	27-3/4	20	1-5/8	24-1/4
18	31	20	1-7/8	27
20	33-3/4	20	2	29-1/2
24	41	20	2-1/2	35-1/2

Bolting Data for ASME B16.5 & BS 1560 Flanges

Nominal Pipe Size	Class 1500			
	Flange Dia.	No. of Bolts	Bolt Diameter	B.C. Diameter
1/4	4-3/4	4	3/4	3-1/4
1/2	5-1/8	4	3/4	3-1/2
3/4	5-7/8	4	7/8	4
1	5-7/8	4	7/8	4
1-1/4	6-1/4	4	7/8	4-3/8
1-1/2	7	4	1	4-7/8
2	8-1/2	8	7/8	6-1/2
2-1/2	9-5/8	8	1	7-1/2
3	10-1/2	8	1-1/8	8
4	12-1/4	8	1-1/4	9-1/2
5	14-3/4	8	1-1/2	11-1/2
6	15-1/2	12	1-3/8	12-1/2
8	19	12	1-5/8	15-1/2
10	23	12	1-7/8	19
12	26-1/2	16	2	22-1/2
14	29-1/2	16	2-1/4	25
16	32-1/2	16	2-1/2	27-3/4
18	36	16	2-3/4	30-1/2
20	38-3/4	16	3	32-3/4
24	46	16	3-1/2	39

Bolting Data for ASME B16.5 & BS 1560 Flanges

Nominal Pipe Size	Class 2500			
	Flange Dia.	No. of Bolts	Bolt Diameter	B.C. Diameter
1/2	5-1/4	4	3/4	3-1/2
3/4	5-1/2	4	3/4	3-3/4
1	6-1/4	4	7/8	4-1/4
1-1/4	7-1/4	4	1	5-1/8
1-1/2	8	4	1-1/8	5-3/4
2	9-1/4	8	1	6-3/4
2-1/2	10-1/2	8	1-1/8	7-3/4
3	12	8	1-1/4	9
4	14	8	1-1/2	10-3/4
5	16-1/2	8	1-3/4	12-3/4
6	19	8	2	14-1/2
8	21-3/4	12	2	17-1/4
10	26-1/2	12	2-1/2	21-1/4
12	30	12	2-3/4	24-3/8

The content of this Gasket Reference Guide relates to Flexitallic's products as supplied. The information contained herein is given in good faith, but no liability will be accepted in relation to same. The revision of products, pursuant to Flexitallic's policy of continuous development, as well as the acquisition of further information, may necessitate revisions to parts or all of this document. Flexitallic's Technical Sales Department will be pleased to update customers, on request. As the company's products are used for a multiplicity of purposes, and as Flexitallic has no control over the method of their application or use, Flexitallic must exclude all conditions or warranties, express or implied, as to their products and/or their fitness for any particular purpose. Any technical cooperation between the Company and its customers is given for the customer's assistance only, and without liability on the part of Flexitallic.

Flexitallic L.P. guarantees that any product of its manufacture, which, upon examination by a Flexitallic representative, is found to be defective in either workmanship or material whereby it is suitable under proper usage and service for the purpose for which is was designed, will be replaced or repaired free of charge including transportation charges but not cost of installation or, at our option, the purchase price will be refunded. The products are not guaranteed as to performance under any specific service nor for any specific period of time. The sale of our products under any other warranty or guarantee express or implied is not authorized by the company.

WARNING:

Properties/applications shown throughout this brochure are typical. Your specific application should not be undertaken without independent study and evaluation for suitability. For specific application recommendations consult Flexitallic. Failure to select the proper sealing products could result in property damage and/or serious personal injury.

Performance data published in this brochure has been developed from field testing, customer field reports and/or in-house testing.

While the utmost care has been used in compiling this brochure, we assume no responsibility for errors. Specifications subject to change without notice. This edition cancels all previous issues. Subject to change without notice.

Flexitallic is a registered trademark for gaskets, seals and other products of Flexitallic.



FLEXSEAL INDUSTRIAL

A FULL LINE GASKET & O-RING SUPPLIER

A Flexitallic® Distributor

CALL 832-445-0000

FAX 832-445-0002

EMAIL sales@flexsealindustrial.com

VISIT www.flexsealindustrial.com

24/7 EMERGENCY CALLOUT SERVICE

Flexseal Industrial is a full line gasket and o-ring distributor. We provide a broad range of products including but not limited to Flexitallic spiral wound gaskets, die cut gaskets, sheet material, Flexpro (kammprofile) gaskets, RTJ's and o-ring seals.

We offer superior customer service and are committed to meeting the needs of all your industrial sealing applications.

SPIRAL WOUND GASKETS



SIGMA



Thermiculite
innovative. versatile. complete.



Flexpro™

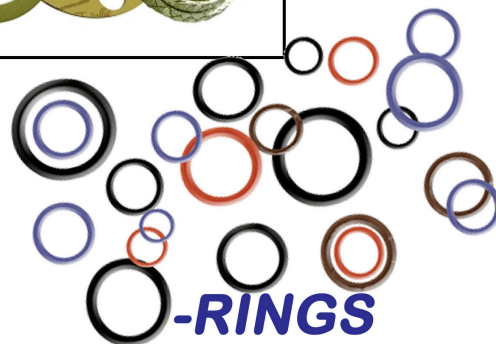

-RINGS